

1.25mm Pitch Super Low profile Crimping Connector

DF14 Series

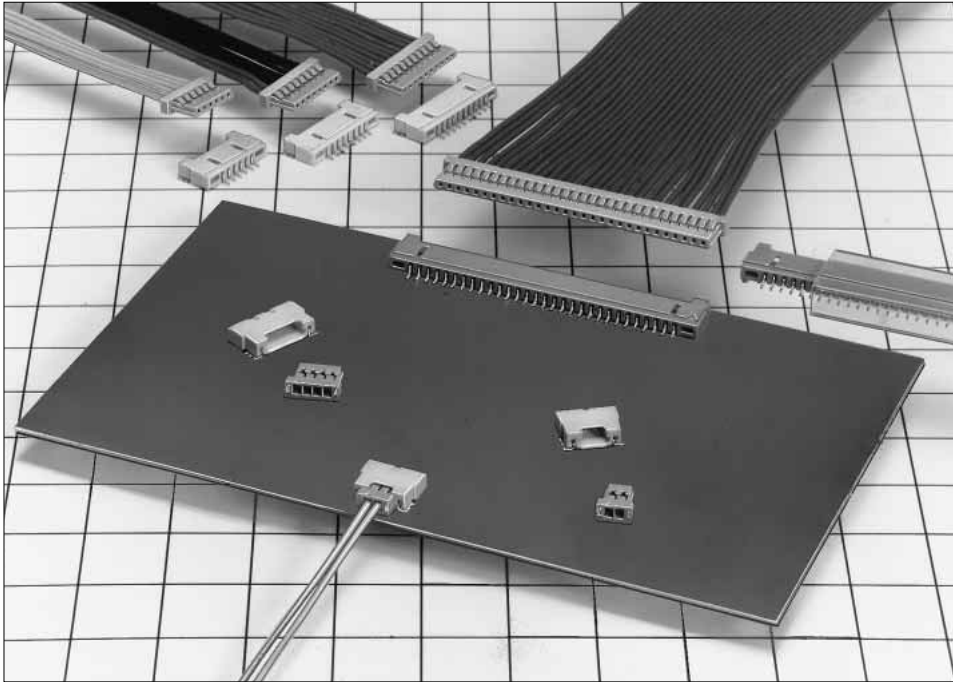

■ Features

1. Super Low Profile

This is a connector special for right angle which has pursued a low profile on the board.

Board mounting height: **2.5mm**

A signal can be fetched from the area where there is no board to board space. (Refer to fig.1)

Offset type is available.

Board mounting height: **1.6mm** (Refer to fig.2)

2. Correspond to Automatic Mounting

The header has the vacuum mount face which enables the vacuum absorption and the automatic mounting by the embossed tape packaging. In addition, the tube packaging can be selected.

3. Four Wall Type Without Friction to Board by Socket

The header has the box structure to prevent from being twisted and has the perfect mis-insertion prevention method. Moreover the header has the wall on the board side and doesn't have any trouble resulted from the friction to board by socket.

In addition, the metal fitting is attached to prevent the solder peel.

■ Applications

LCD, Note PC, Mobile Terminal Small business equipment, Video camera

Board Mounting Figure

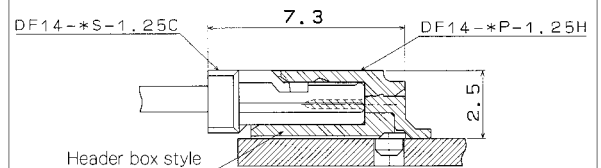

DF14(A)

fig.1

Board Mounting Figure

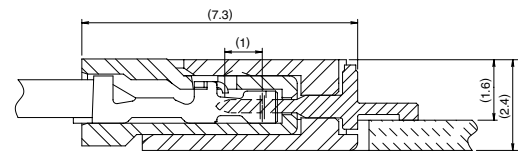

DF14H

fig.2

Product Specifications

Rating	Current rating	1A	Operating Temperature Range	-35 to +85°C (Note 1)	Storage Temperature Range	-10 to +60°C (Note 2)
	Voltage rating	150V AC		Operating Moisture Range		40 to 80%

Item	Specification	Condition
1. Insulation Resistance	500M ohms Min	100V DC
2. Withstanding voltage	No flashover or insulation breakdown.	500V AC/1 minute
3. Contact Resistance	30m ohms Max	100mA
4. Insertion/Extraction Force	MIN0.15N (15gf), MAX3N (300gf)	Measure at the square steel pin of 0.3±0.002mm
5. Vibration	No electrical discontinuity of 1μs or more	Frequency: 10 to 55 Hz, single amplitude of 0.75 mm, 2 hours in each of the 3 directions.
6. Humidity (Steady state)	Contact resistance: 30m ohms Max Insulation resistance: 500M ohms Min	96 hours at temperature of 40°C and humidity of 90% to 95%
7. Temperature Cycle	Contact resistance: 30m ohms Max Insulation resistance: 500M ohms Min	(-25°C: 30 minutes → 5 to 35°C: 10 minutes → 85°C: 30 minutes → 5 to 35°C: 10 minutes) 5 cycles
8. Durability (Mating/un-mating)	Contact resistance: 30m ohms Max	Tin plating: 30 cycles Gold plating: 50 cycles
9. Resistance to Soldering heat	No deformation of components affecting performance.	Reflow: At the recommended temperature profile
		Manual soldering: 300°C for 3 seconds

Note 1: Includes temperature rise caused by current flow.

Note 2: The term "storage" refers to products stored for long period of time prior to mounting and use. Operating Temperature Range and Humidity range covers non conducting condition of installed connectors in storage, shipment or during transportation.

Note 3: Information contained in this catalog represents general requirements for this Series. Contact us for the drawings and specifications for a specific part number shown.

Material

Product	Part	Material	Finish	Remarks
Crimping Socket	Insulator	Polyamide	Beige	UL94V-0
Crimping Contact for Socket	Contact	Phosphor Copper	Tin-copper plated or gold plated	————
Pin Header	Insulator	Polyamide	Beige	UL94V-0
	Contact	Brass	Tin-copper plated or gold plated	————
	Fitting	Phosphor copper	Tin-copper plated	————

Ordering Information

Connector

DF 14 # - * S - 1.25 C

① ② ③ ④ ⑤ ⑥

① Series Name: DF14	④ Connector Type S: Single row socket P: Single row pin header
② Blank: Standard, with boss A: on-board, without boss H: offset	⑤ Contact Pitch: 1.25mm
③ Number of Contacts: 2 to 10, 15, 20, 25, 30	⑥ Contact Type C: Crimping socket H: Right angle SMT

Contact

DF14 - 2628 SCF A

① ② ③

① Applicable cable size 2628: AWG26 to 28 3032: AWG30 to 32	② Packaging Type SCF: Socket contact/reel
	③ Plating Type Blank: Tin plated A: Gold plated

DF14 Series 1.25mm Pitch Super Low profile Crimping Connector

■Crimping Socket

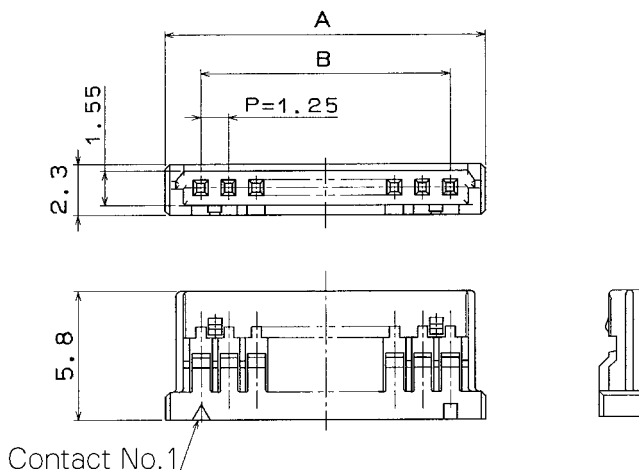
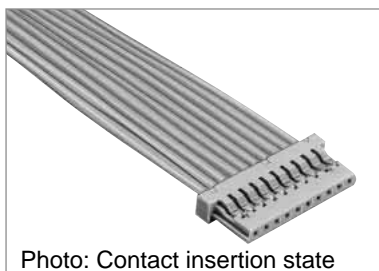

Unit: mm

Part Number	CL No.	Number of Contacts	A	B	RoHS
DF14- 2S-1.25C	538-0005-8	2	4.45	1.25	Yes
DF14- 3S-1.25C	538-0006-0	3	5.70	2.50	
DF14- 4S-1.25C	538-0007-3	4	6.95	3.75	
DF14- 5S-1.25C	538-0008-6	5	8.20	5.00	
DF14- 6S-1.25C	538-0009-9	6	9.45	6.25	
DF14- 7S-1.25C	538-0010-8	7	10.70	7.50	
DF14- 8S-1.25C	538-0011-0	8	11.95	8.75	
DF14- 9S-1.25C	538-0013-6	9	13.20	10.00	
DF14-10S-1.25C	538-0014-9	10	14.45	11.25	
DF14-15S-1.25C	538-0054-3	15	20.70	17.50	
DF14-20S-1.25C	538-0059-7	20	26.95	23.75	
DF14-25S-1.25C	538-0064-7	25	33.20	30.00	
DF14-30S-1.25C	538-0012-3	30	39.45	36.25	

Note 1. The quantity is delivered per bag(100 pcs). If needed, please order the products per bag.

■Socket Crimping Contact

Part Number	CL No.	Packaging Type	Quantity	Finish	RoHS
DF14-2628SCF	538-0001-7-**-	Reel	10,000	Tin plated	Yes
DF14-3032SCF	538-0003-2-**-	Reel		Gold plated	
DF14-2628SCFA	538-0002-0-**-	Reel			
DF14-3032SCFA	538-0004-5-**-	Reel			

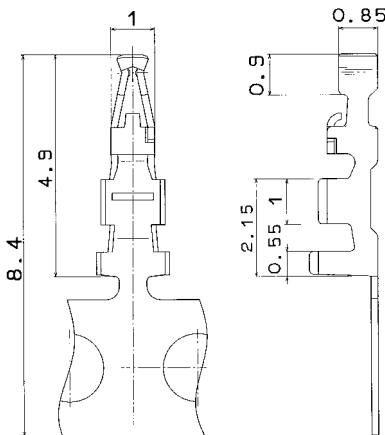
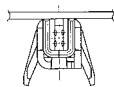

●Applicable Cable (Tin plating Annealed copper wire)

Conductor Size (Wire construction)	Jacket Diameter
AWG26(7 cores/0.16mm)	φ0.54 to φ1mm
AWG28(7 cores/0.127mm)	
AWG30(7 cores/0.1mm)	
AWG32(7 cores/0.08mm)	

●Recommended Cable

UL1571

●Strip Length

1.2 to 1.9mm

Note: If other cables are used instead of the applicable cable, contact Hirose sales department.

◆Applicable Crimping Tool

Type	Part Number	CL No.	Applicable Contact
Applicator	AP105-DF14-2628S	901-4548-1	DF14-2628SCF/SCFA
	AP105-DF14-3032S	901-4544-0	DF14-3032SCF/SCFA
Press Main Unit	CM-105	901-0005-4	_____
Manual Crimping Tool	DF14-2628/CR-HT	550-0261-1	DF14-2628SCF/SCFA
	DF14-3032/CR-HT	550-0262-4	DF14-3032SCF/SCFA

Note 1. If a trouble has occurred due to tools, which are not designated by Hirose, Hirose won't guarantee any product.

Note 2. Use the reel contact sequentially cut for manual crimping tool.

Right Angle Pin Header (SMT)

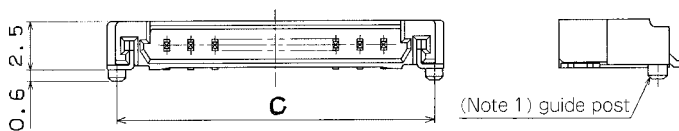
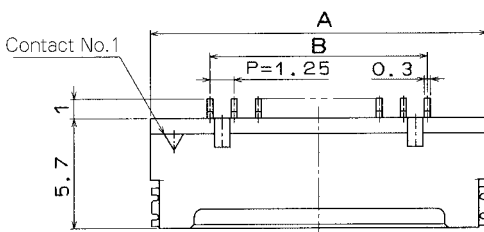

Note 1. "Without boss" indicates the style with no boss.

PCB mounting pattern

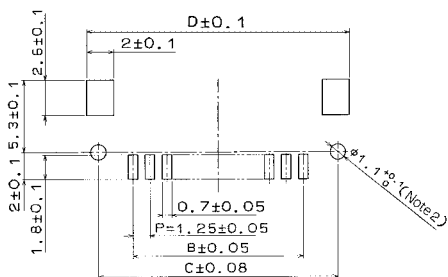

Note 2. "Without boss" indicates that no hole is needed.

Tube Packaging Dimensions

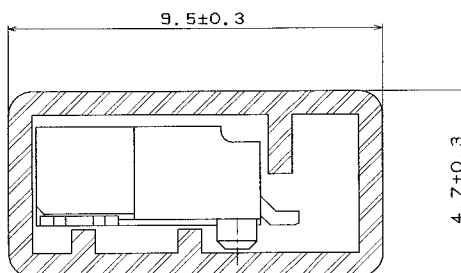

[Specific No.]—**, (**)
 (25): Tin-copper plated tube packaging
 (26): Tin-copper plated embossed tape packaging
 (55): Gold plated tube packaging
 (56): Gold plated embossed tape packaging

Unit: mm

With boss		Without boss		Number of Contacts	A	B	C	D	Tube Packaging Quantity	RoHS
Part Number	CL No.	Part Number	CL No.							
DF14- 2P-1.25H(**)	538-0021-4-**	DF14A- 2P-1.25H(**)	538-0033-3-**	2	7.45	1.25	6.45	8.05	66	Yes
DF14- 3P-1.25H(**)	538-0022-7-**	DF14A- 3P-1.25H(**)	538-0034-6-**	3	8.70	2.50	7.70	9.30	56	
DF14- 4P-1.25H(**)	538-0023-0-**	DF14A- 4P-1.25H(**)	538-0035-9-**	4	9.95	3.75	8.95	10.55	49	
DF14- 5P-1.25H(**)	538-0024-2-**	DF14A- 5P-1.25H(**)	538-0036-1-**	5	11.20	5.00	10.20	11.80	44	
DF14- 6P-1.25H(**)	538-0025-5-**	DF14A- 6P-1.25H(**)	538-0037-4-**	6	12.45	6.25	11.45	13.05	39	
DF14- 7P-1.25H(**)	538-0026-8-**	DF14A- 7P-1.25H(**)	538-0038-7-**	7	13.70	7.50	12.70	14.30	36	
DF14- 8P-1.25H(**)	538-0027-0-**	DF14A- 8P-1.25H(**)	538-0039-0-**	8	14.95	8.75	13.95	15.55	32	
DF14- 9P-1.25H(**)	538-0028-3-**	DF14A- 9P-1.25H(**)	538-0040-9-**	9	16.20	10.00	15.20	16.80	30	
DF14-10P-1.25H(**)	538-0029-6-**	DF14A-10P-1.25H(**)	538-0041-1-**	10	17.45	11.25	16.45	18.05	28	
DF14-15P-1.25H(**)	538-0084-4-**	DF14A-15P-1.25H(**)	538-0114-3-**	15	23.70	17.50	22.70	24.30	20	
DF14-20P-1.25H(**)	538-0089-8-**	DF14A-20P-1.25H(**)	538-0119-7-**	20	29.95	23.75	28.95	30.55	16	
DF14-25P-1.25H(**)	538-0094-8-**	DF14A-25P-1.25H(**)	538-0124-7-**	25	36.20	30.00	35.20	36.80	13	
DF14-30P-1.25H(**)	538-0020-1-**	DF14A-30P-1.25H(**)	538-0045-2-**	30	42.45	36.25	41.45	43.05	11	

Note 1. Please order the tube packaging product, multiplying the packaging quantity (pcs.).

Note 2. Please order the embossed tape packaging product according to reel number. (1000 pcs./reel)

DF14 Series 1.25mm Pitch Super Low profile Crimping Connector

■ Right Angle Pin Header (Offset, SMT)

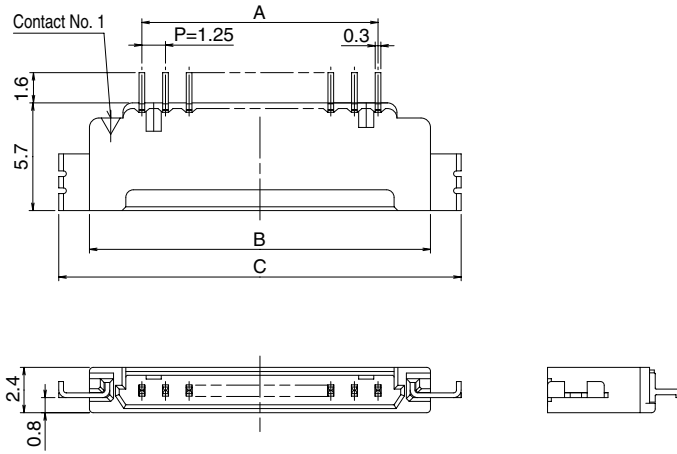
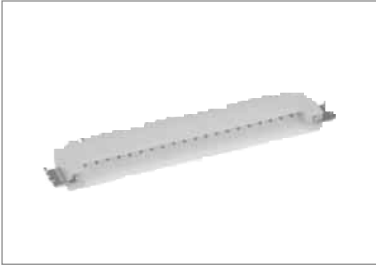

◆ PCB mounting pattern

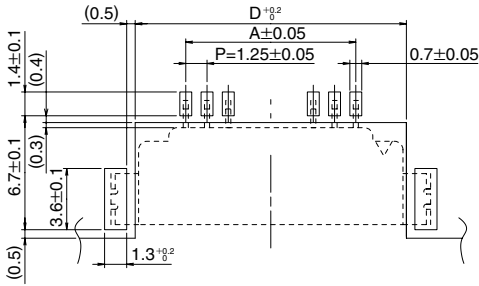

[Specific No.]—**, (**)
 (56): Gold plated embossed tape packaging

Unit: mm

Part Number	CL No.	Number of Contacts	A	B	C	D	RoHS
DF14H- 2P-1.25H(**)	538-0177-3-**	2	1.25	6.8	10.1	7.2	Yes
DF14H-20P-1.25H(**)	538-0167-0-**	30	23.75	29.3	32.6	29.7	
DF14H-30P-1.25H(**)	538-0188-0-**	30	36.25	41.8	45.1	42.2	

Note 1. Please order the embossed tape packaging product according to reel number. (1000 pcs./reel)

◆ Embossed Carrier Tape Dimensions (JIS-C-0806)

■ 2 to 10 Contacts

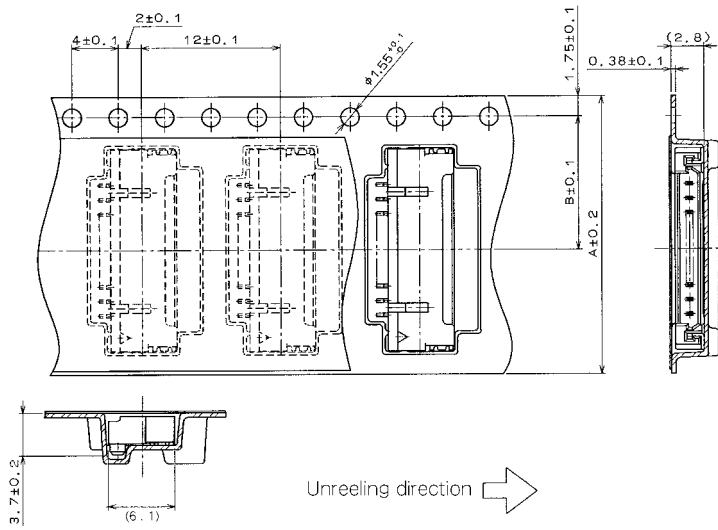

■ 15, 20, 25, 30 Contacts

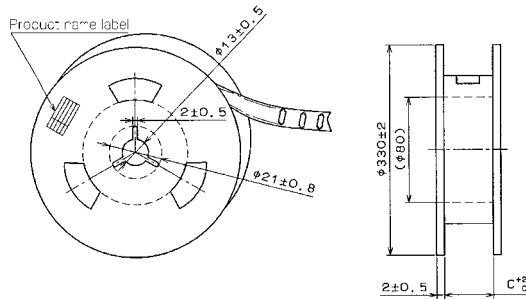
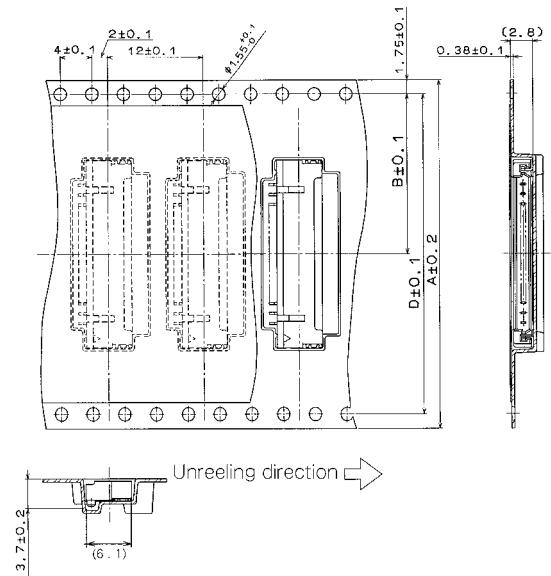

Unit: mm

Inserted Connector	Number of Contacts	A	B	C	D
DF14/14A- 2P-1.25H	2	16	7.5	16.4	—
DF14/14A- 3P-1.25H	3	16	7.5	16.4	—
DF14/14A- 4P-1.25H	4	24	11.5	24.4	—
DF14/14A- 5P-1.25H	5	24	11.5	24.4	—
DF14/14A- 6P-1.25H	6	24	11.5	24.4	—
DF14/14A- 7P-1.25H	7	24	11.5	24.4	—
DF14/14A- 8P-1.25H	8	24	11.5	24.4	—
DF14/14A- 9P-1.25H	9	24	11.5	24.4	—
DF14/14A-10P-1.25H	10	24	11.5	24.4	—
DF14/14A-15P-1.25H	15	44	20.2	44.4	40.4
DF14/14A-20P-1.25H	20	44	20.2	44.4	40.4
DF14/14A-25P-1.25H	25	56	26.2	56.4	52.4
DF14/14A-30P-1.25H	30	56	26.2	56.4	52.4

DF14 Series 1.25mm Pitch Super Low profile Crimping Connector

◆ Embossed Carrier Tape Dimensions (JIS-C-0806)

DF14H-*P- 1.25H

■ 2 Contacts

■ 20, 30 Contacts

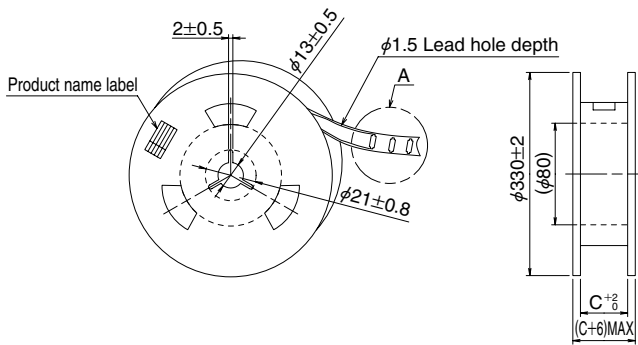
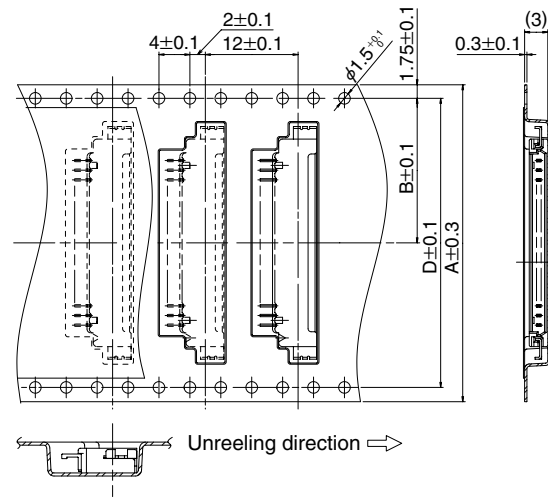
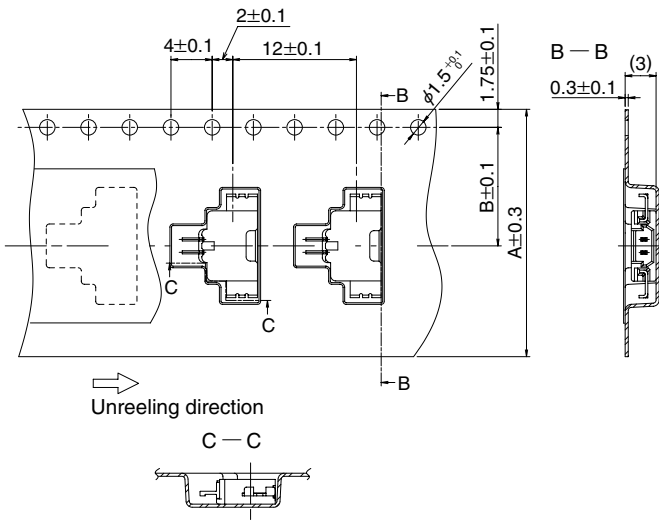

Unit: mm

Inserted Connector	Number of Contacts	A	B	C	D
DF14H- 2P-1.25H	2	24	11.5	24.4	—
DF14H- 20P-1.25H	20	44	20.2	44.4	40.4
DF14H- 30P-1.25H	30	56	26.2	56.4	52.4

◆Precautions

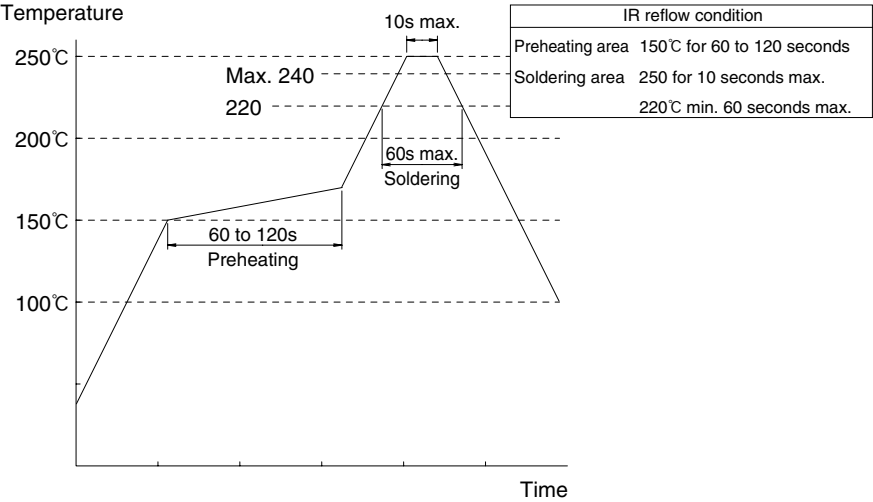
<p>1. Recommended Temperature Profile (SMT)</p>	 <p>Note 1. Up to 2 cycles of Reflow soldering are possible under the same conditions, provided that there is a return to normal temperature between the first and second cycle.</p> <p>Note 2. The temperature profile indicates the board surface temperature at the point of contacts with the connector terminals.</p>
<p>2. Recommended Manual Soldering Condition (SMT)</p>	<p>Manual soldering: 290°C for 2 seconds</p>
<p>3. Recommended Screen Thickness (SMT)</p>	<p>0.15 to 0.2mm</p>
<p>4. Board Sled (SMT)</p>	<p>Max 0.03mm at the connector center area, based on both connector edges</p>
<p>5. Cleaning Condition</p>	<p>Refer to Nylon Connector Use Hand book.</p>
<p>6. Connection Condition</p>	<p>Refer to Nylon Connector Use Hand book. ■Be careful to carry out the crimping operation according to the "Crimping Condition Sheet" and "Crimping Quality Reference", because the crimping contact style is too small.</p>
<p>7. Precautions</p>	<p>Refer to Nylon Connector Use Hand book.</p>
<p>8. Cautions</p>	<p>■Be careful for an excessive scoop insertion/extraction, which will cause damage to the product.</p>

◆Precautions

<Precautions at Time of Insertion>

Handling

Method: Lightly grasping the base of the cable, press the connector with your finger and insert it.

Insertion Angle

[Caution] Do not insert at an angle of 30° or greater. Doing so will cause contact deformation or case damage.

Method: Insert with the connector parallel.

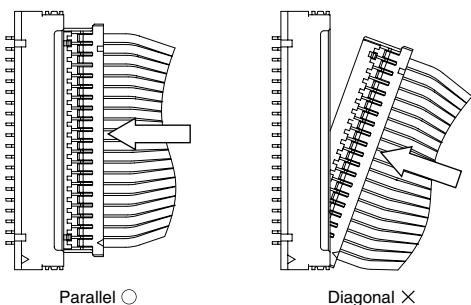
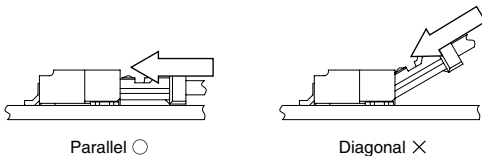

<Precautions at Time of Disconnection>

Handling

Method: Grasp the cable so that the entire cable is pulled evenly and pull it out.

Angle of Removal

[Caution] Do not remove at an angle of 30° or greater. Doing so will cause contact deformation or case damage.

Method: Remove with the connector parallel.

